

CONTRACTOR NOTE:
 ALL WALLS ARE TO BE PLUMB
 & LEVEL. INSTALLER TO USE
 NECESSARY SHIMS IF WALLS
 ARE NOT PLUMB OR LEVEL.
 SHIMS (NOT BY ESTOLGA)

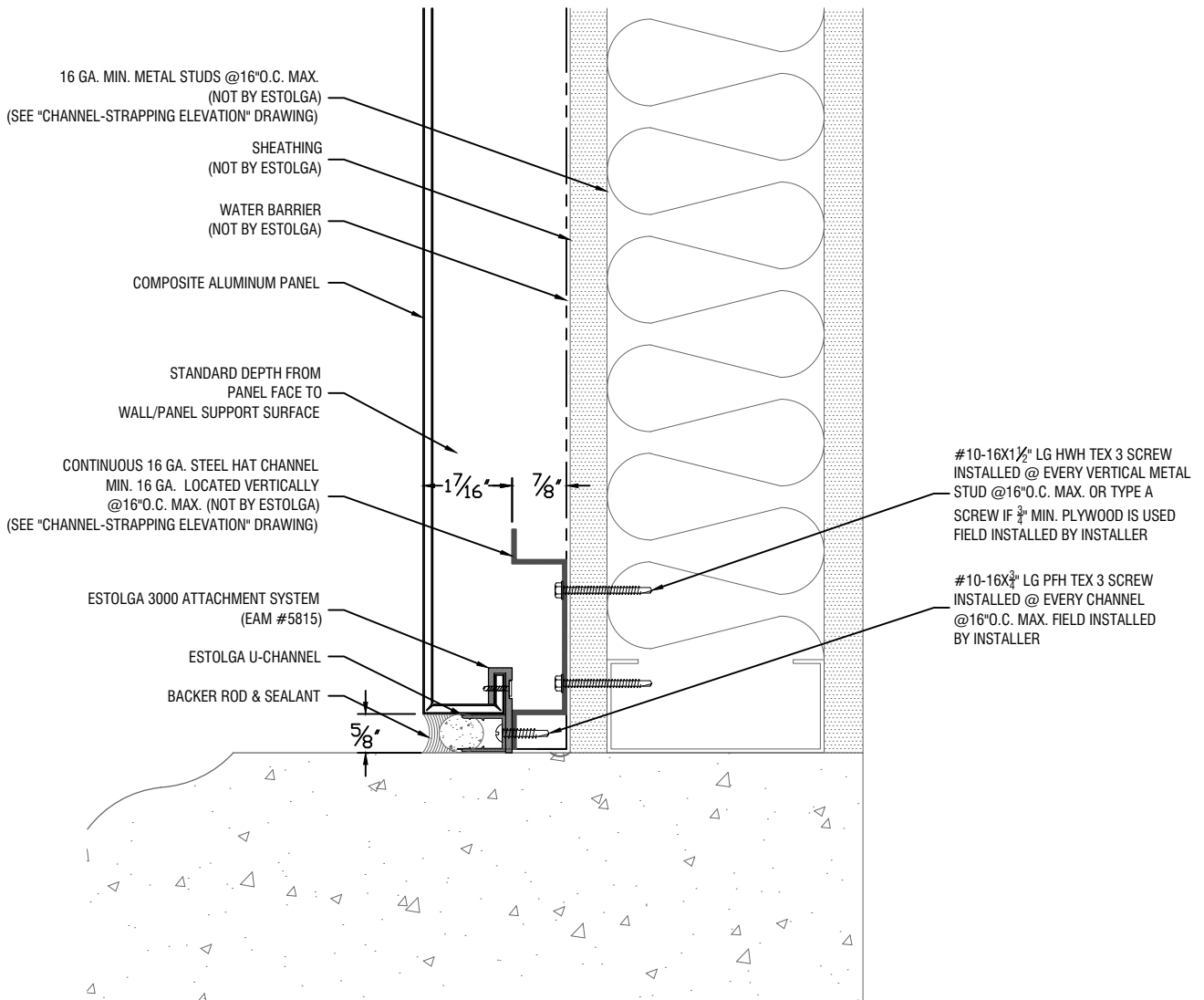

Base Detail



ESTOLGA® 3000 WET SEAL SYSTEM (SYSTEM INSTALLED ON CONTINUOUS HAT CHANNEL)

TO PURCHASE ENGINEERED/FABRICATED PANEL SYSTEM, CONTACT ALLIED METAL: (888) 520-8800
 TO PURCHASE ENGINEERED ESTOLGA ATTACHMENT SYSTEMS CONTACT WRISCO: (800)753-9400
 TESTED ASTM E-330, ASTM E-331, ASTM E-283, AAMA-508
 PATENTED PRODUCTS 7.621.084, 084 B2, 7.472.521, 521 B2, 8.127.502, 8.015.917 PATENT PENDING, DESIGN PATENT PENDING

CONTRACTOR NOTE:
 ALL WALLS ARE TO BE PLUMB & LEVEL. INSTALLER TO USE NECESSARY SHIMS IF WALLS ARE NOT PLUMB OR LEVEL. SHIMS (NOT BY ESTOLGA)

16 GA. MIN. METAL STUDS @16"O.C. MAX. (NOT BY ESTOLGA) (SEE "CHANNEL-STRAPPING ELEVATION" DRAWING)

#10-16X1 1/2" LG HWH TEX 3 SCREW INSTALLED @ EVERY VERTICAL METAL STUD @16"O.C. MAX. OR TYPE A SCREW IF 3/4" MIN. PLYWOOD IS USED FIELD INSTALLED BY INSTALLER

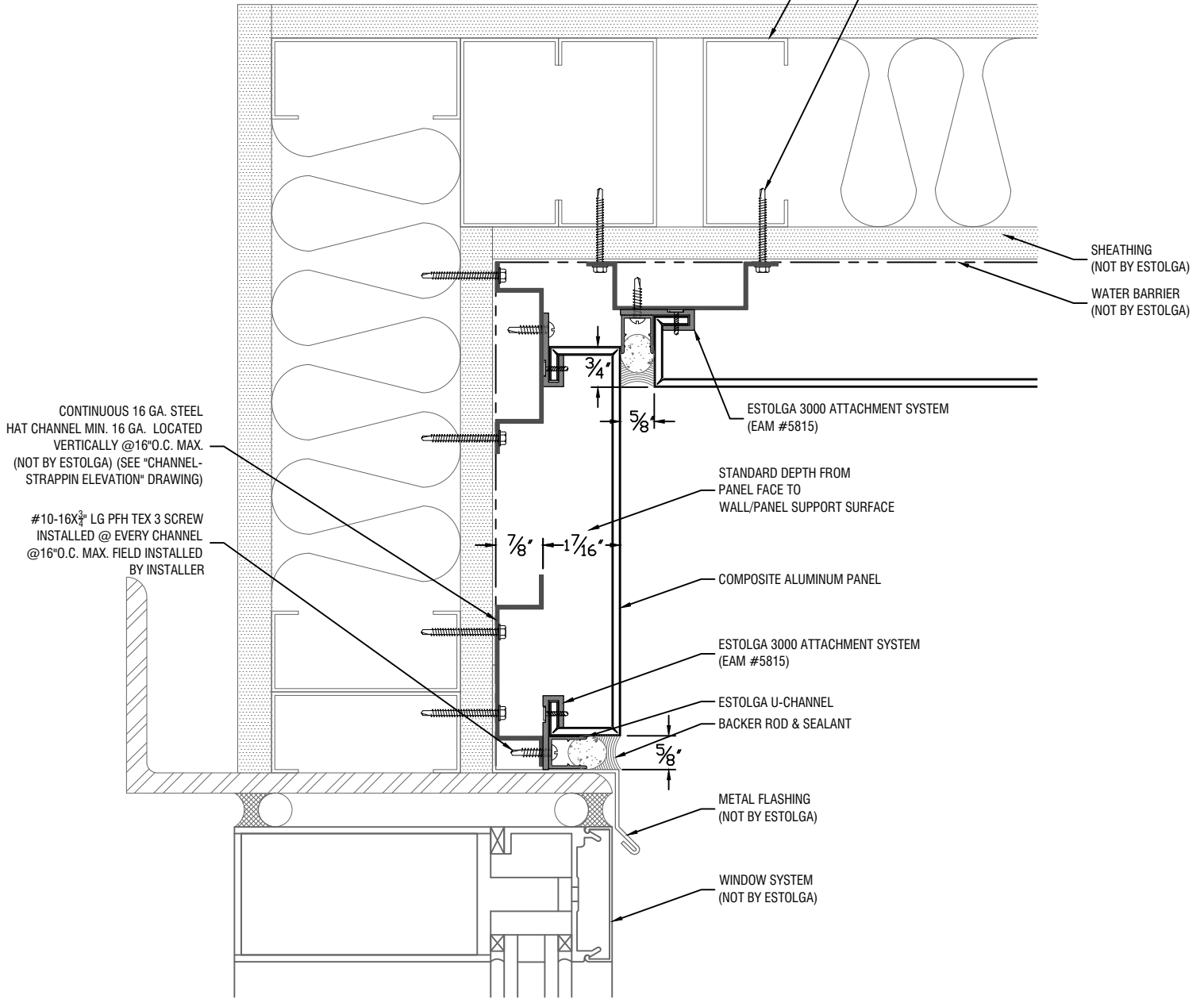

Canopy Detail



ESTOLGA® 3000 WET SEAL SYSTEM (SYSTEM INSTALLED ON CONTINUOUS HAT CHANNEL)

TO PURCHASE ENGINEERED/FABRICATED PANEL SYSTEM, CONTACT ALLIED METAL: (888) 520-8800
 TO PURCHASE ENGINEERED ESTOLGA ATTACHMENT SYSTEMS CONTACT WRISCO: (800)753-9400
 TESTED ASTM E-330, ASTM E-331, ASTM E-283, AAMA-508
 PATENTED PRODUCTS 7.621.084, 084 B2, 7.472.521, 521 B2, 8.127.502, 8.015.917 PATENT PENDING, DESIGN PATENT PENDING

Confidential Document: Property of ESTOLGA. Any transfer of this document without the express written permission of ESTOLGA is unlawful. This document includes: Originals, duplicates, and electronic versions. All are exclusive. Information contained herein or related hereto is intended only for evaluation by technically skilled persons, with any use thereof to be at their independent discretion and risk. Such information is believed to be reliable, but ESTOLGA shall have no responsibility or liability for results obtained or damages resulting from such use. ESTOLGA grants no license under, and shall have no responsibility or liability for infringement of, any patent proprietary right. Sales of ESTOLGA products shall be independent and subject exclusively to warranties set forth in ESTOLGA acknowledgment. The foregoing may be waived or modified only in writing by an ESTOLGA officer.

CONTRACTOR NOTE:
 ALL WALLS ARE TO BE PLUMB & LEVEL. INSTALLER TO USE NECESSARY SHIMS IF WALLS ARE NOT PLUMB OR LEVEL. SHIMS (NOT BY ESTOLGA)

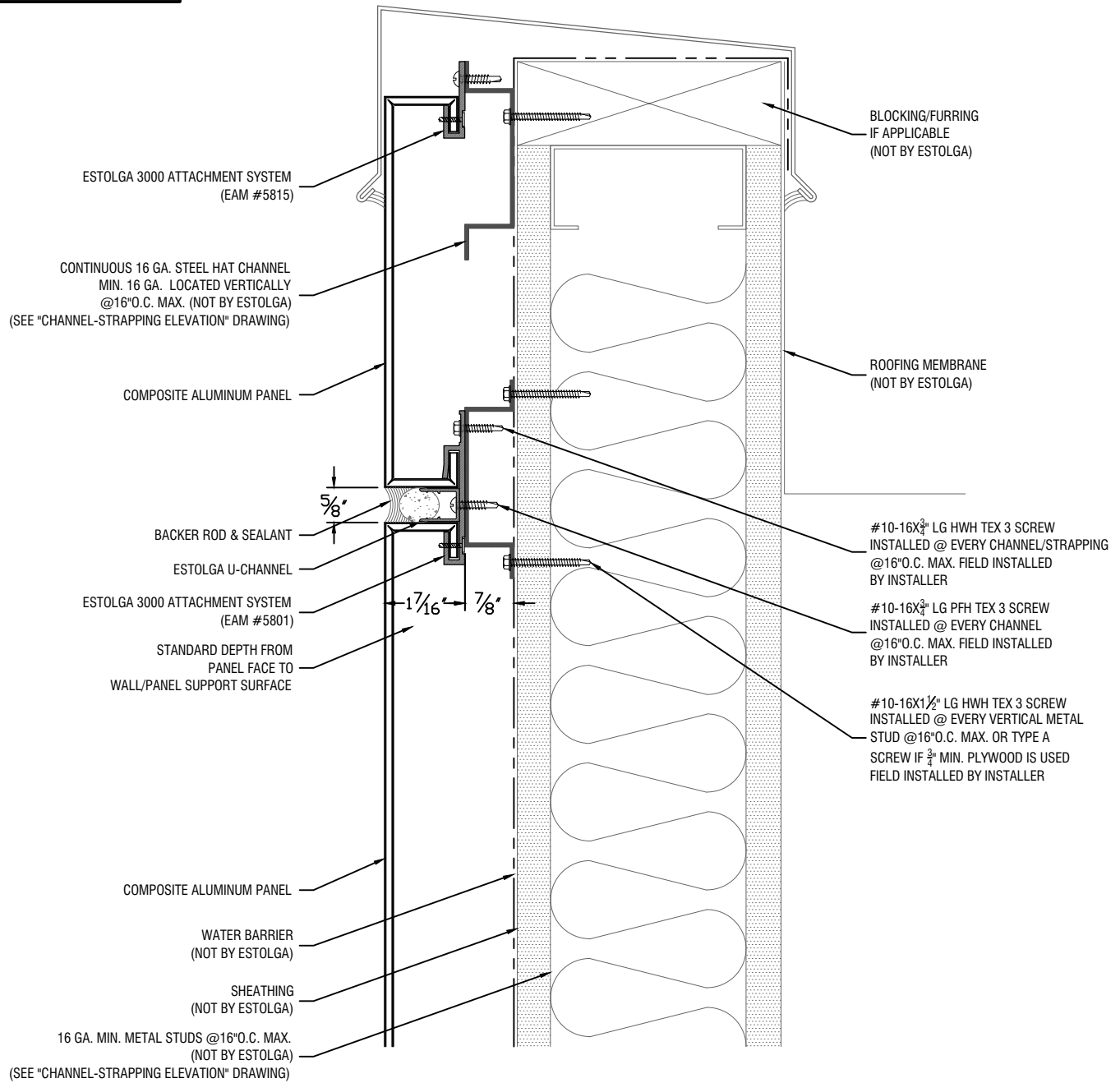

Coping Detail-1



ESTOLGA® 3000 WET SEAL SYSTEM (SYSTEM INSTALLED ON CONTINUOUS HAT CHANNEL)

TO PURCHASE ENGINEERED/FABRICATED PANEL SYSTEM, CONTACT ALLIED METAL: (888) 520-8800
 TO PURCHASE ENGINEERED ESTOLGA ATTACHMENT SYSTEMS CONTACT WRISCO: (800)753-9400
 TESTED ASTM E-330, ASTM E-331, ASTM E-283, AAMA-508
 PATENTED PRODUCTS 7.621.084, 084 B2, 7.472.521, 521 B2, 8.127.502, 8.015.917 PATENT PENDING, DESIGN PATENT PENDING

CONTRACTOR NOTE:
 ALL WALLS ARE TO BE PLUMB
 & LEVEL. INSTALLER TO USE
 NECESSARY SHIMS IF WALLS
 ARE NOT PLUMB OR LEVEL.
 SHIMS (NOT BY ESTOLGA)

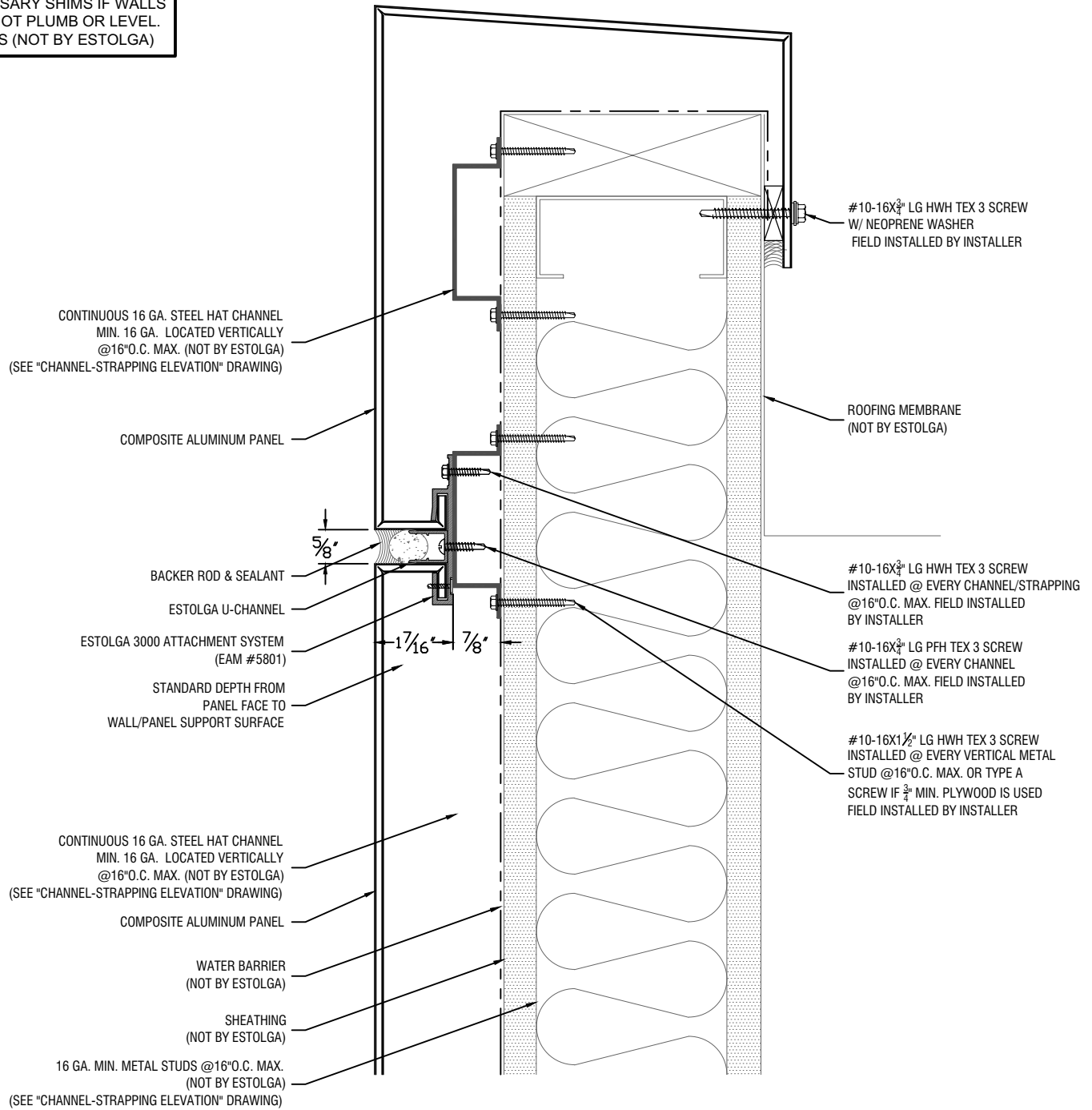

Coping Detail-2



ESTOLGA® 3000 WET SEAL SYSTEM (SYSTEM INSTALLED ON CONTINUOUS HAT CHANNEL)

TO PURCHASE ENGINEERED/FABRICATED PANEL SYSTEM, CONTACT ALLIED METAL: (888) 520-8800
 TO PURCHASE ENGINEERED ESTOLGA ATTACHMENT SYSTEMS CONTACT WRISCO: (800)753-9400
 TESTED ASTM E-330, ASTM E-331, ASTM E-283, AAMA-508
 PATENTED PRODUCTS 7.621.084, 084 B2, 7.472.521, 521 B2, 8.127.502, 8.015.917 PATENT PENDING, DESIGN PATENT PENDING

CONTRACTOR NOTE:
 ALL WALLS ARE TO BE PLUMB & LEVEL. INSTALLER TO USE NECESSARY SHIMS IF WALLS ARE NOT PLUMB OR LEVEL. SHIMS (NOT BY ESTOLGA)

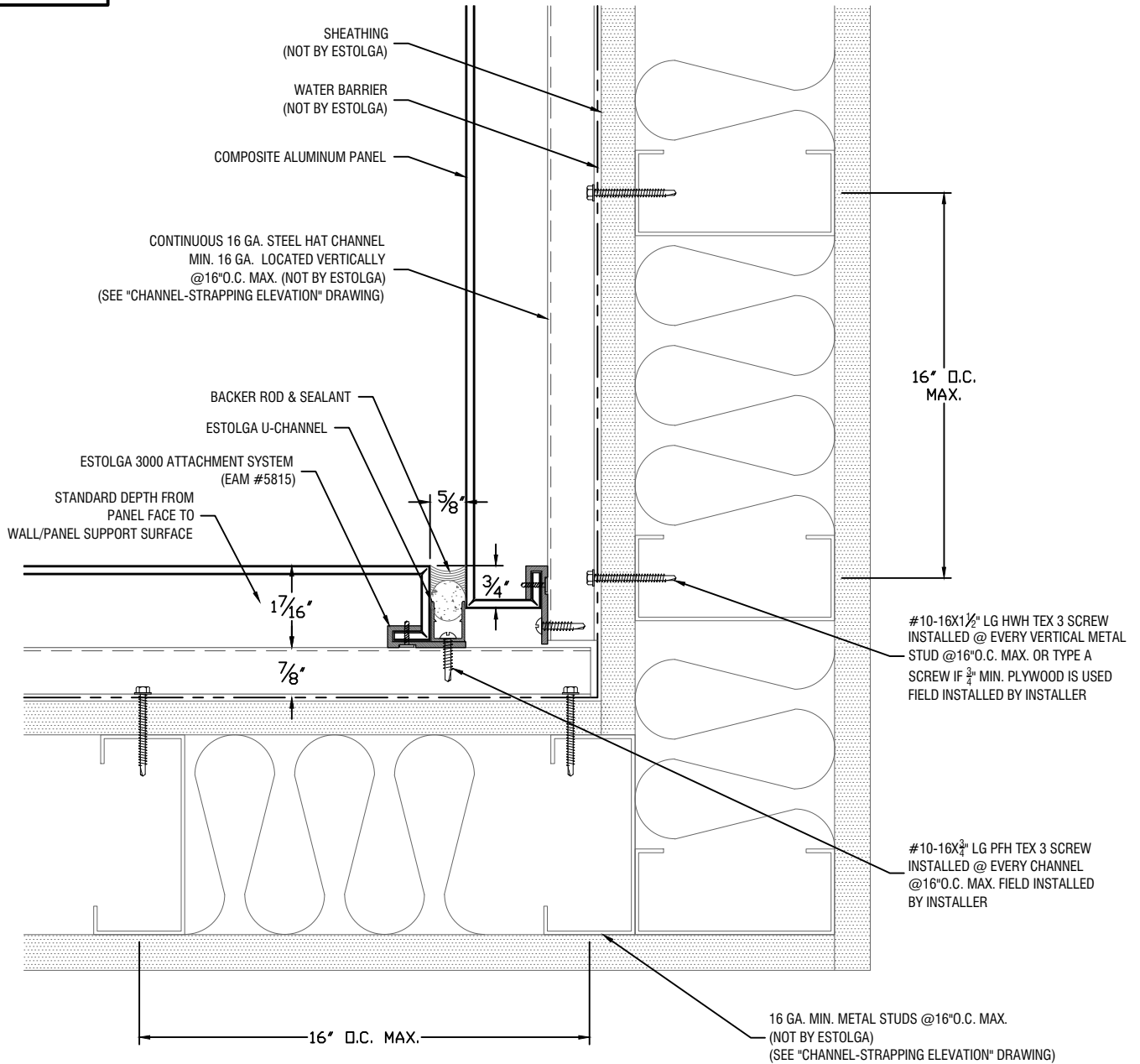

Inside Corner Detail



ESTOLGA[®] 3000 WET SEAL SYSTEM (SYSTEM INSTALLED ON CONTINUOUS HAT CHANNEL)

TO PURCHASE ENGINEERED/FABRICATED PANEL SYSTEM, CONTACT ALLIED METAL: (888) 520-8800
 TO PURCHASE ENGINEERED ESTOLGA ATTACHMENT SYSTEMS CONTACT WRISCO: (800)753-9400
 TESTED ASTM E-330, ASTM E-331, ASTM E-283, AAMA-508
 PATENTED PRODUCTS 7.621.084, 084 B2, 7.472.521, 521 B2, 8.127.502, 8.015.917 PATENT PENDING, DESIGN PATENT PENDING

Confidential Document: Property of ESTOLGA. Any transfer of this document without the express written permission of ESTOLGA is unlawful. This document includes: Originals, duplicates, and electronic versions. All are exclusive. Information contained herein or related hereto is intended only for evaluation by technically skilled persons, with any use thereof to be at their independent discretion and risk. Such information is believed to be reliable, but ESTOLGA shall have no responsibility or liability for results obtained or damages resulting from such use. ESTOLGA grants no license under, and shall have no responsibility or liability for infringement of, any patent proprietary right. Sales of ESTOLGA products shall be independent and subject exclusively to warranties set forth in ESTOLGA acknowledgment. The foregoing may be waived or modified only in writing by an ESTOLGA officer.

CONTRACTOR NOTE:
 ALL WALLS ARE TO BE PLUMB & LEVEL. INSTALLER TO USE NECESSARY SHIMS IF WALLS ARE NOT PLUMB OR LEVEL. SHIMS (NOT BY ESTOLGA)

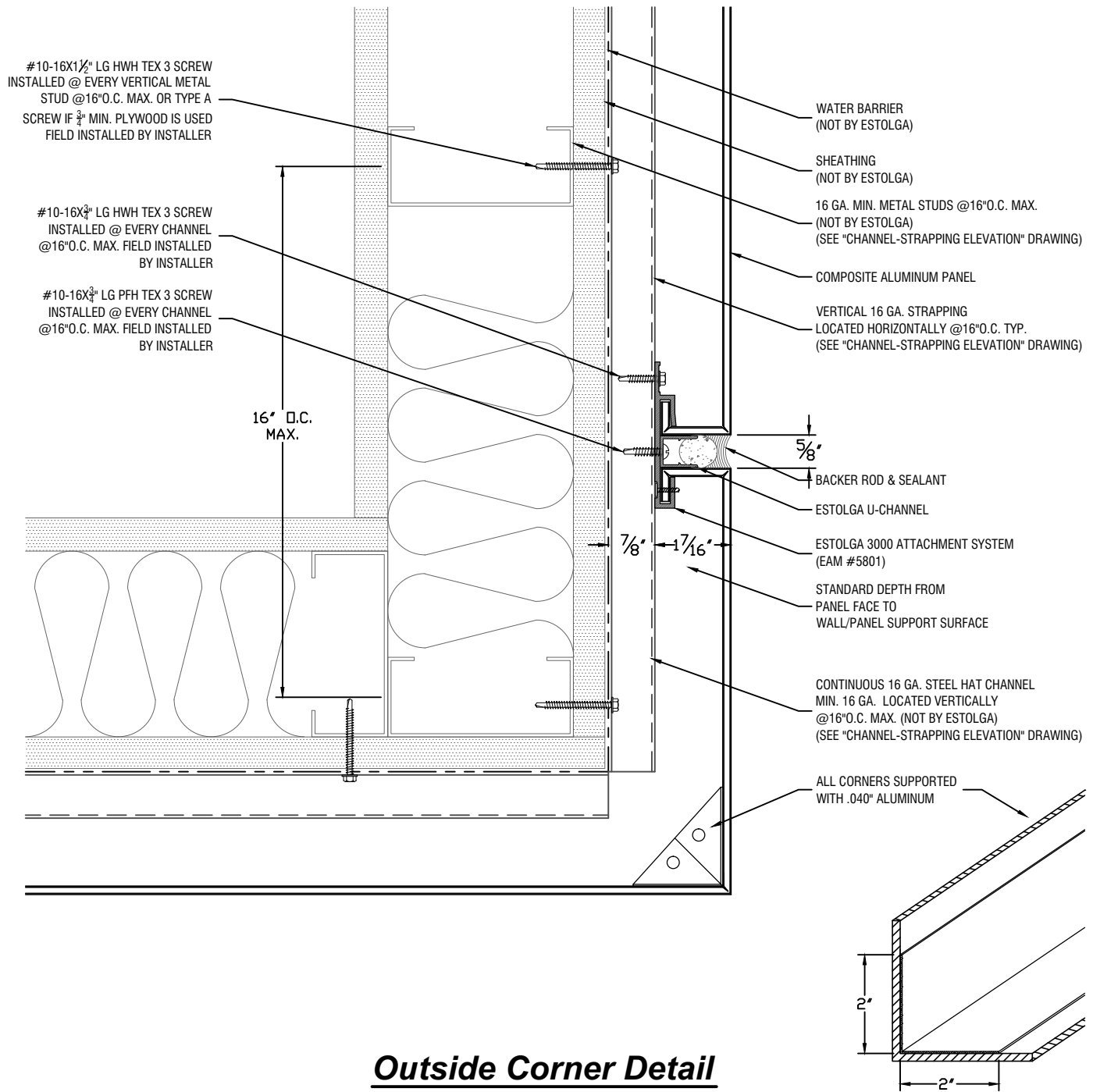

Outside Corner Detail



**ESTOLGA® 3000 WET SEAL SYSTEM
 (SYSTEM INSTALLED ON CONTINUOUS HAT CHANNEL)**

TO PURCHASE ENGINEERED/FABRICATED PANEL SYSTEM, CONTACT ALLIED METAL: (888) 520-8800
 TO PURCHASE ENGINEERED ESTOLGA ATTACHMENT SYSTEMS CONTACT WRISCO: (800)753-9400
 TESTED ASTM E-330, ASTM E-331, ASTM E-283, AAMA-508
 PATENTED PRODUCTS 7.621.084, 084 B2, 7.472.521, 521 B2, 8.127.502, 8.015.917 PATENT PENDING, DESIGN PATENT PENDING

CONTRACTOR NOTE:
 ALL WALLS ARE TO BE PLUMB
 & LEVEL. INSTALLER TO USE
 NECESSARY SHIMS IF WALLS
 ARE NOT PLUMB OR LEVEL.
 SHIMS (NOT BY ESTOLGA)

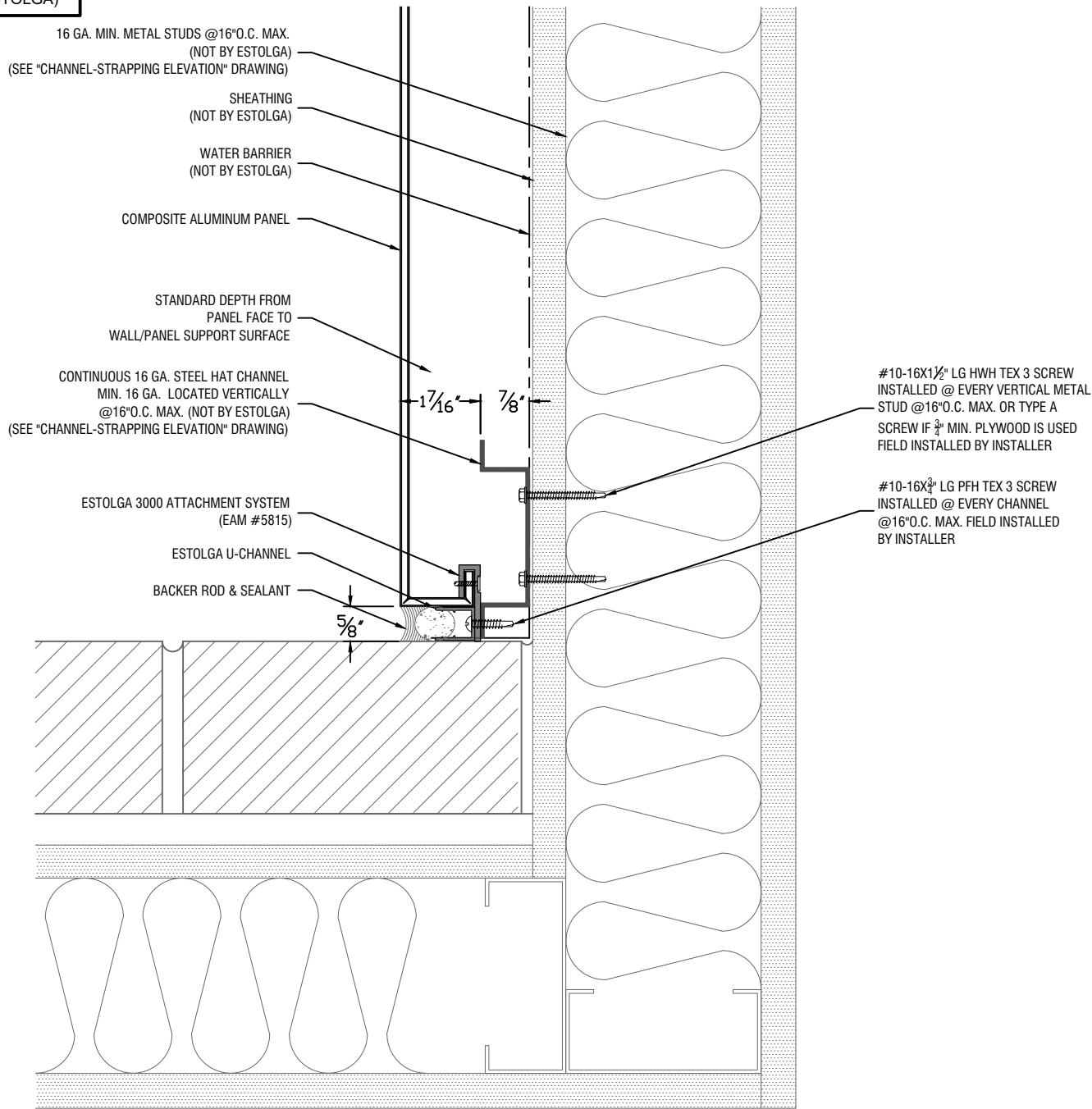

Plan Detail @ Adjacent Wall



ESTOLGA® 3000 WET SEAL SYSTEM
 (SYSTEM INSTALLED ON CONTINUOUS HAT CHANNEL)

TO PURCHASE ENGINEERED/FABRICATED PANEL SYSTEM, CONTACT ALLIED METAL: (888) 520-8800
 TO PURCHASE ENGINEERED ESTOLGA ATTACHMENT SYSTEMS CONTACT WRISCO: (800)753-9400
 TESTED ASTM E-330, ASTM E-331, ASTM E-283, AAMA-508
 PATENTED PRODUCTS 7.621.084, 084 B2, 7.472.521, 521 B2, 8.127.502, 8.015.917 PATENT PENDING, DESIGN PATENT PENDING

Confidential Document: Property of ESTOLGA. Any transfer of this document without the express written permission of ESTOLGA is unlawful. This document includes: Originals, duplicates, and electronic versions. All are exclusive. Information contained herein or related hereto is intended only for evaluation by technically skilled persons, with any use thereof to be at their independent discretion and risk. Such information is believed to be reliable, but ESTOLGA shall have no responsibility or liability for results obtained or damages resulting from such use. ESTOLGA grants no license under, and shall have no responsibility or liability for infringement of, any patent proprietary right. Sales of ESTOLGA products shall be independent and subject exclusively to warranties set forth in ESTOLGA acknowledgment. The foregoing may be waived or modified only in writing by an ESTOLGA officer.

CONTRACTOR NOTE:
 ALL WALLS ARE TO BE PLUMB
 & LEVEL. INSTALLER TO USE
 NECESSARY SHIMS IF WALLS
 ARE NOT PLUMB OR LEVEL.
 SHIMS (NOT BY ESTOLGA)

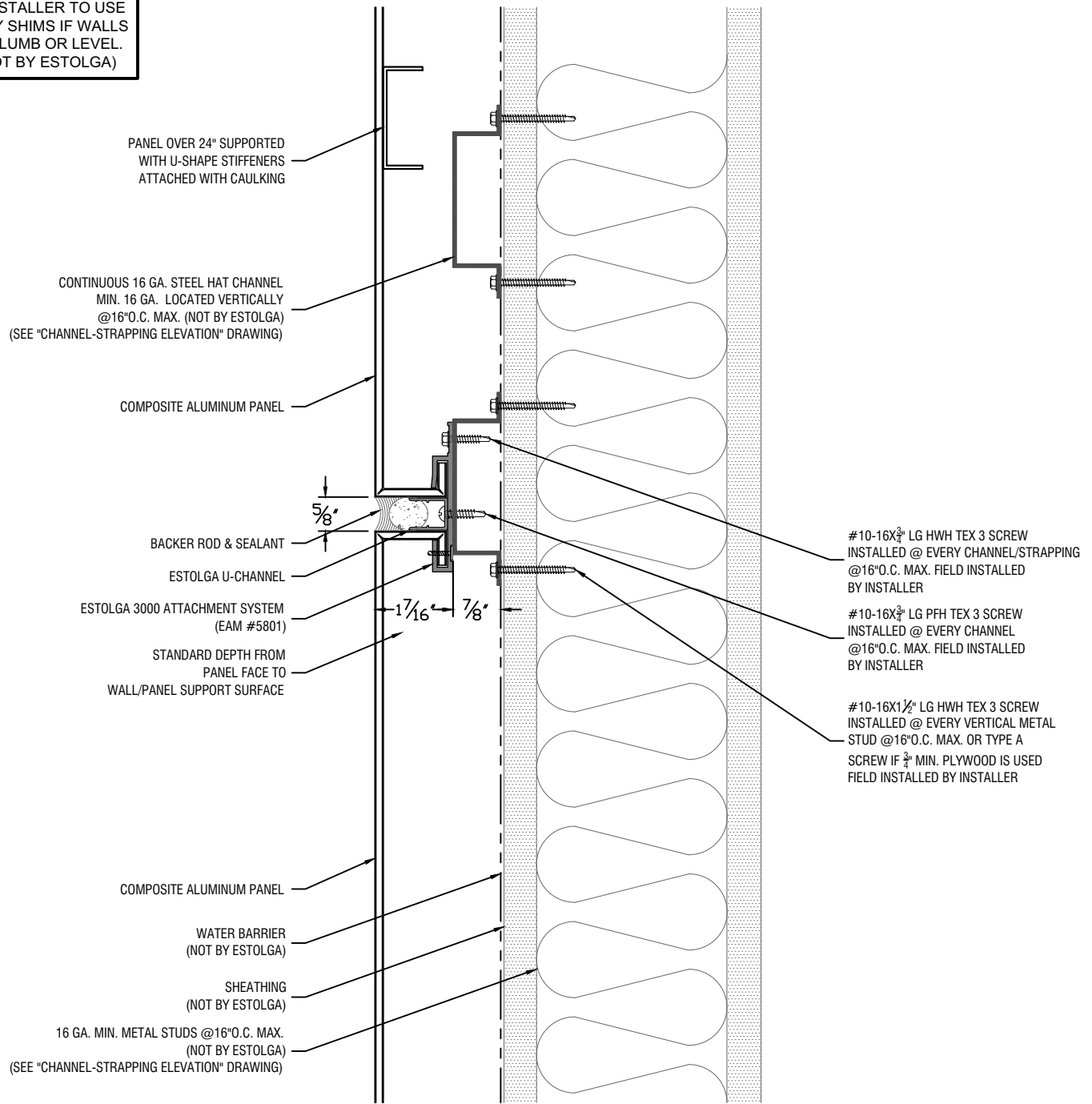

Typical Horizontal Joint Detail



ESTOLGA® 3000 WET SEAL SYSTEM
 (SYSTEM INSTALLED ON CONTINUOUS HAT CHANNEL)

TO PURCHASE ENGINEERED/FABRICATED PANEL SYSTEM, CONTACT ALLIED METAL: (888) 520-8800
 TO PURCHASE ENGINEERED ESTOLGA ATTACHMENT SYSTEMS CONTACT WRISCO: (800)753-9400
 TESTED ASTM E-330, ASTM E-331, ASTM E-283, AAMA-508
 PATENTED PRODUCTS 7.621.084, 084 B2, 7.472.521, 521 B2, 8.127.502, 8.015.917 PATENT PENDING, DESIGN PATENT PENDING

Confidential Document: Property of ESTOLGA. Any transfer of this document without the express written permission of ESTOLGA is unlawful. This document includes: Originals, duplicates, and electronic versions. All are exclusive. Information contained herein or related hereto is intended only for evaluation by technically skilled persons, with any use thereof to be at their independent discretion and risk. Such information is believed to be reliable, but ESTOLGA shall have no responsibility or liability for results obtained or damages resulting from such use. ESTOLGA grants no license under, and shall have no responsibility or liability for infringement of, any patent proprietary right. Sales of ESTOLGA products shall be independent and subject exclusively to warranties set forth in ESTOLGA acknowledgment. The foregoing may be waived or modified only in writing by an ESTOLGA officer.

CONTRACTOR NOTE:
 ALL WALLS ARE TO BE PLUMB
 & LEVEL. INSTALLER TO USE
 NECESSARY SHIMS IF WALLS
 ARE NOT PLUMB OR LEVEL.
 SHIMS (NOT BY ESTOLGA)

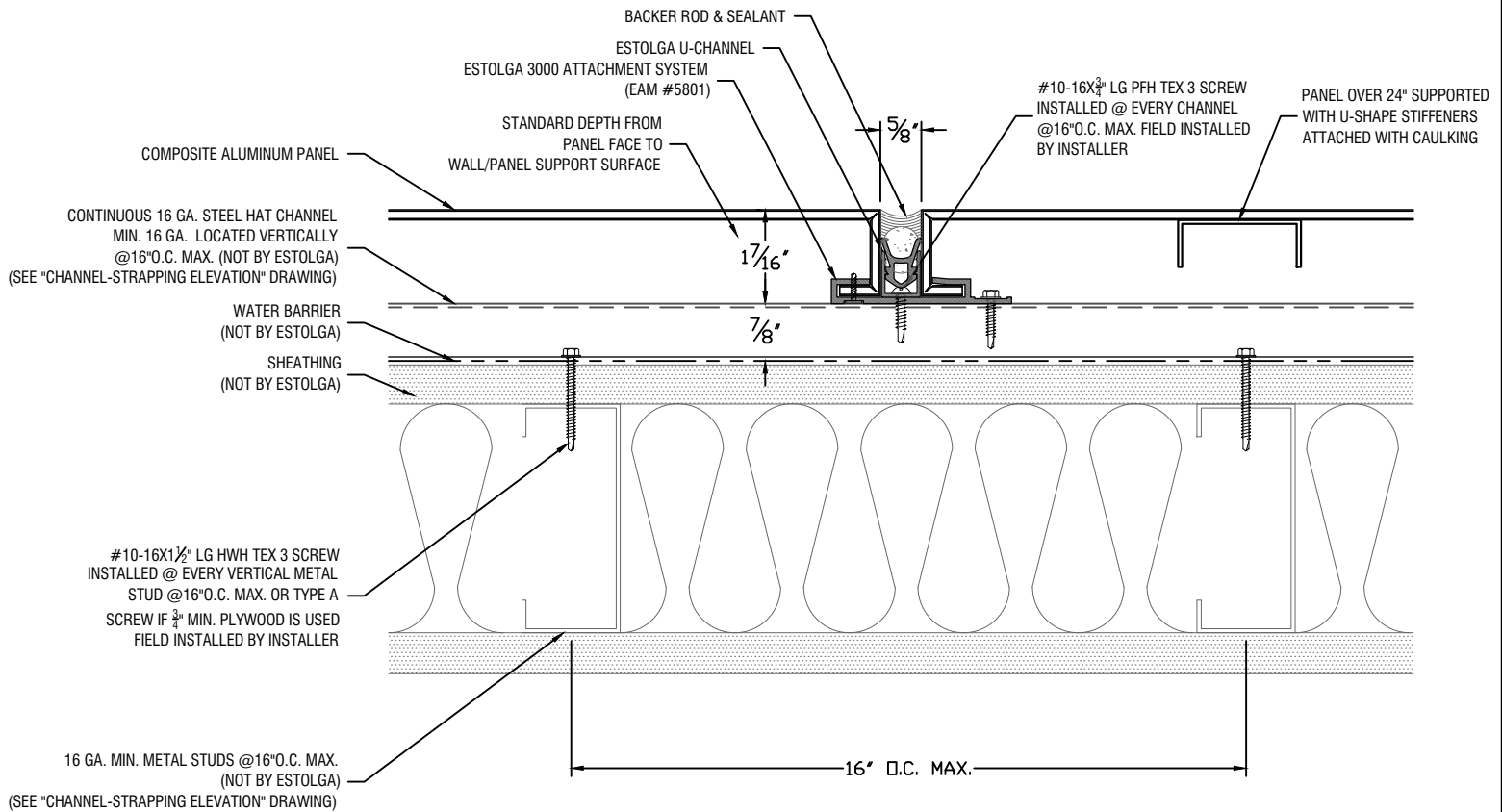

Typical Vertical Joint Detail



ESTOLGA® 3000 WET SEAL SYSTEM (SYSTEM INSTALLED ON CONTINUOUS HAT CHANNEL)

TO PURCHASE ENGINEERED/FABRICATED PANEL SYSTEM, CONTACT ALLIED METAL: (888) 520-8800
 TO PURCHASE ENGINEERED ESTOLGA ATTACHMENT SYSTEMS CONTACT WRISCO: (800)753-9400
 TESTED ASTM E-330, ASTM E-331, ASTM E-283, AAMA-508
 PATENTED PRODUCTS 7.621.084, 084 B2, 7.472.521, 521 B2, 8.127.502, 8.015.917 PATENT PENDING, DESIGN PATENT PENDING

CONTRACTOR NOTE:
 ALL WALLS ARE TO BE PLUMB
 & LEVEL. INSTALLER TO USE
 NECESSARY SHIMS IF WALLS
 ARE NOT PLUMB OR LEVEL.
 SHIMS (NOT BY ESTOLGA)

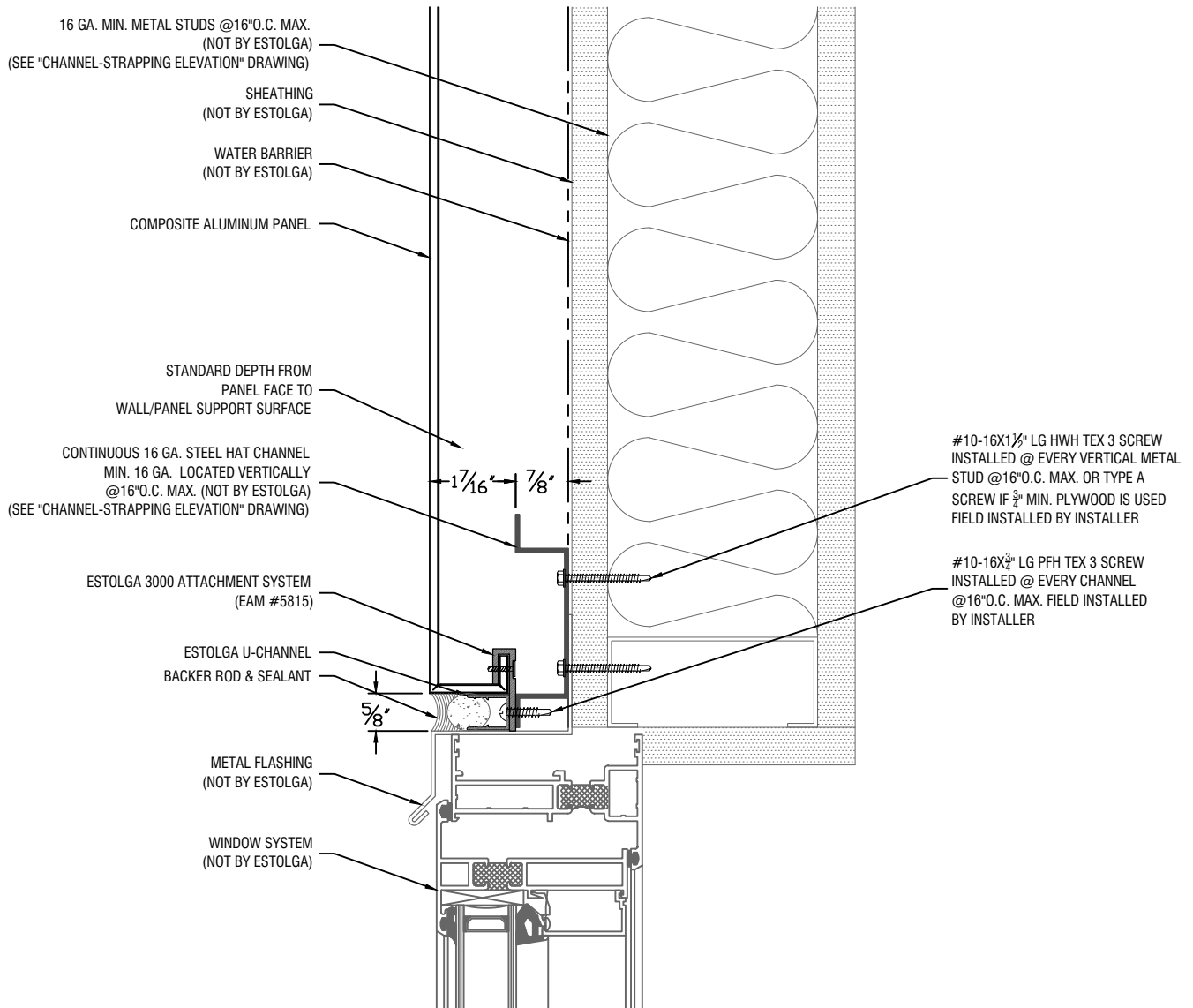

Window Head Detail



ESTOLGA® 3000 WET SEAL SYSTEM (SYSTEM INSTALLED ON CONTINUOUS HAT CHANNEL)

TO PURCHASE ENGINEERED/FABRICATED PANEL SYSTEM, CONTACT ALLIED METAL: (888) 520-8800
 TO PURCHASE ENGINEERED ESTOLGA ATTACHMENT SYSTEMS CONTACT WRISCO: (800)753-9400
 TESTED ASTM E-330, ASTM E-331, ASTM E-283, AAMA-508
 PATENTED PRODUCTS 7.621.084, 084 B2, 7.472.521, 521 B2, 8.127.502, 8.015.917 PATENT PENDING, DESIGN PATENT PENDING

CONTRACTOR NOTE:
 ALL WALLS ARE TO BE PLUMB
 & LEVEL. INSTALLER TO USE
 NECESSARY SHIMS IF WALLS
 ARE NOT PLUMB OR LEVEL.
 SHIMS (NOT BY ESTOLGA)

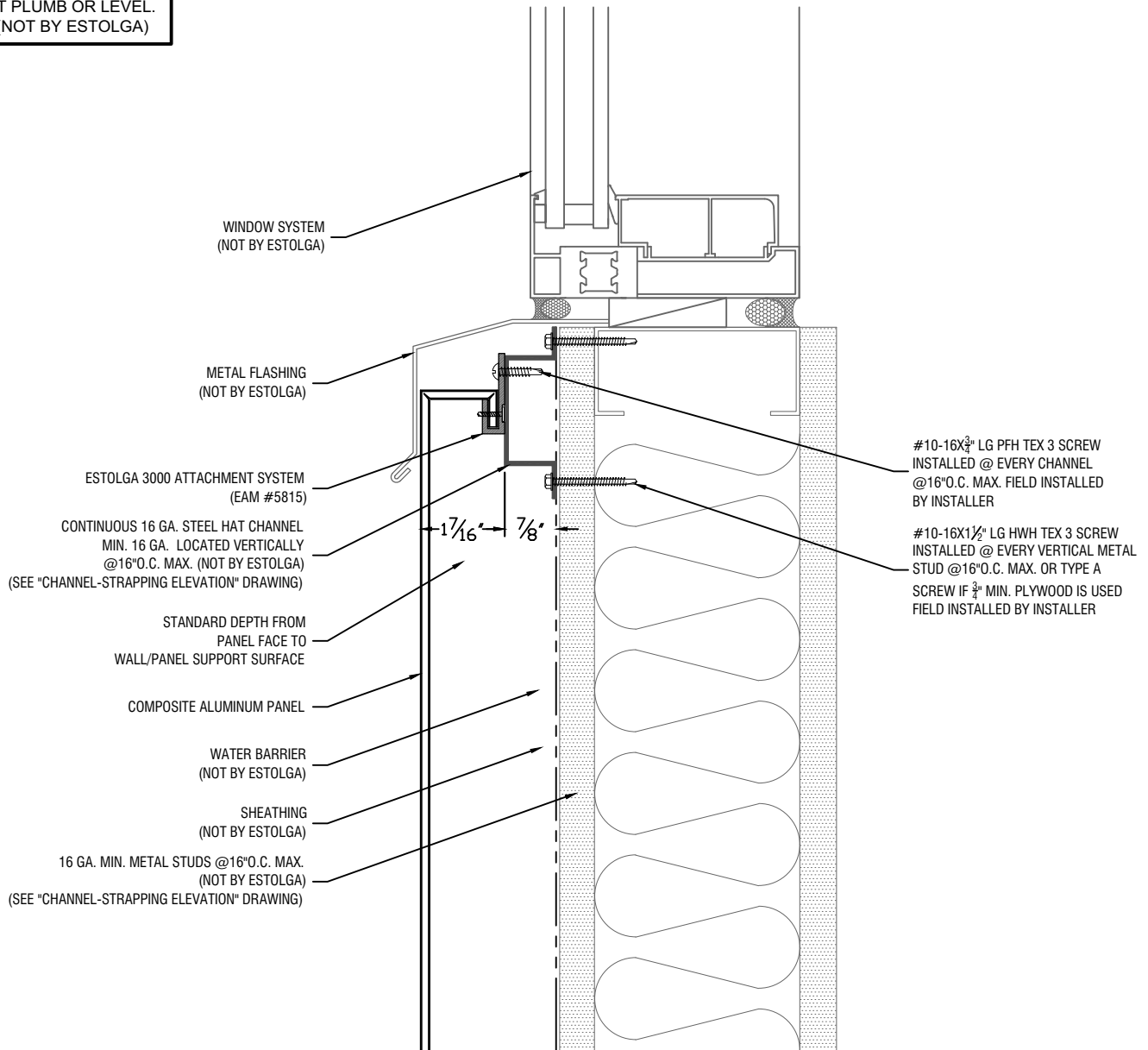

Window Sill Detail



ESTOLGA® 3000 WET SEAL SYSTEM (SYSTEM INSTALLED ON CONTINUOUS HAT CHANNEL)

TO PURCHASE ENGINEERED/FABRICATED PANEL SYSTEM, CONTACT ALLIED METAL: (888) 520-8800
 TO PURCHASE ENGINEERED ESTOLGA ATTACHMENT SYSTEMS CONTACT WRISCO: (800)753-9400
 TESTED ASTM E-330, ASTM E-331, ASTM E-283, AAMA-508
 PATENTED PRODUCTS 7.621.084, 084 B2, 7.472.521, 521 B2, 8.127.502, 8.015.917 PATENT PENDING, DESIGN PATENT PENDING